

OPTIONAL 2" PLEATED FILTER (NOT SHOWN) SLIDING FRAME ONLY TO EITHER SIDE.

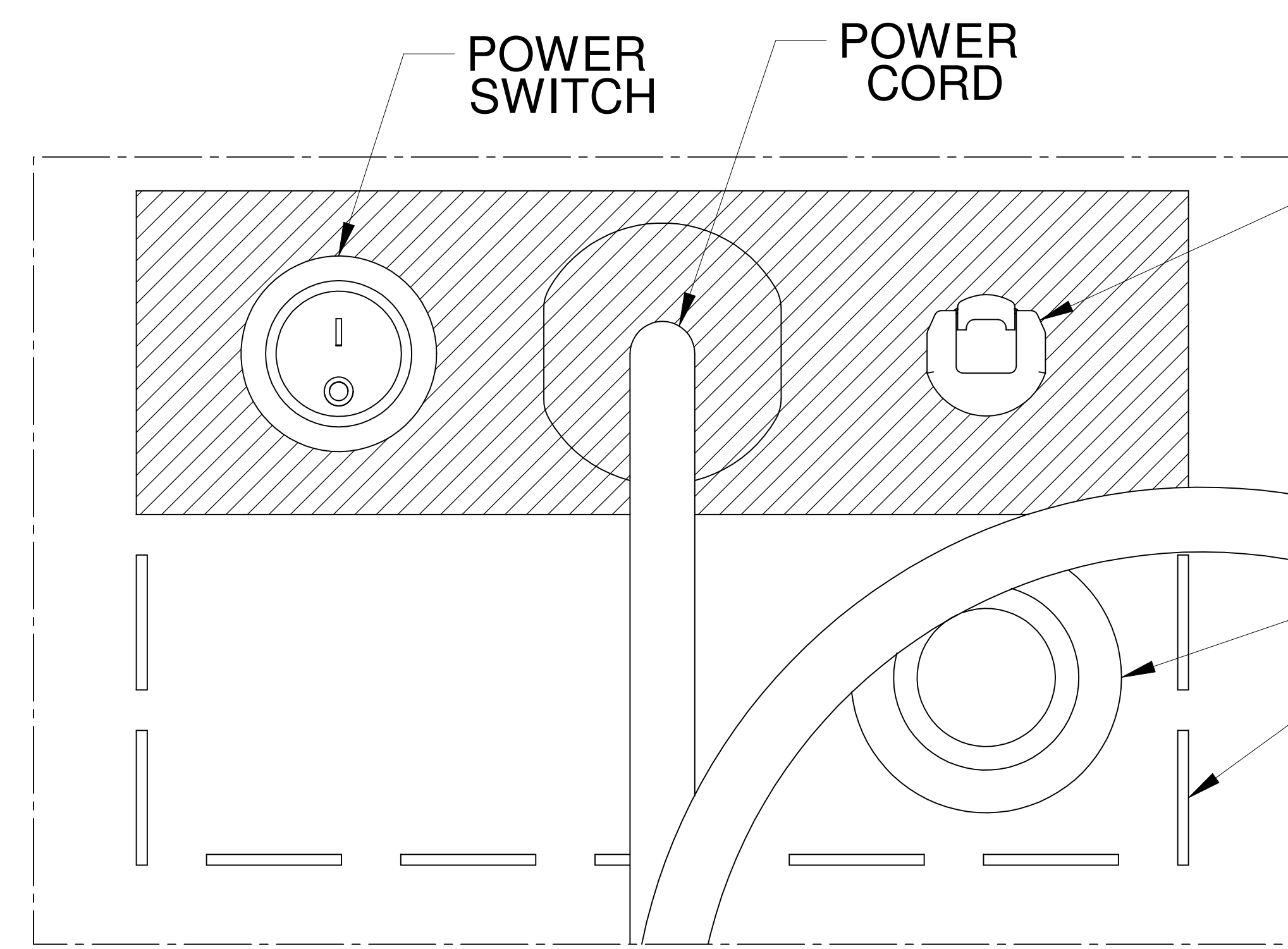

DETAIL A

OPTION: DRY CONTACT
OTHER OPTIONS REQUIRE EXPANDED CUTOUT

OPTION: REMOTELY MOUNTED TEMPERATURE CONTROLLER. REQUIRES EXPANDED CUTOUT INDICATED.

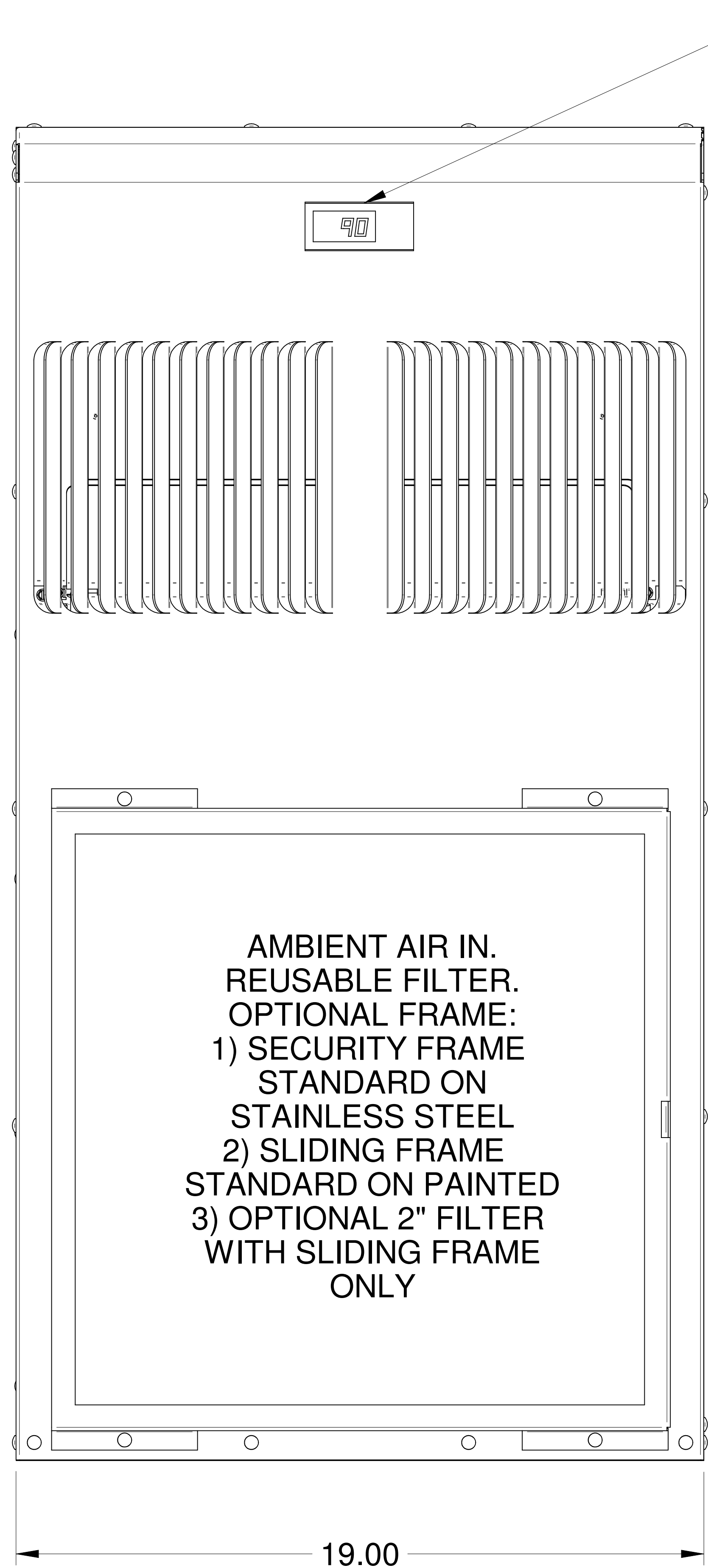

DIGITAL TEMPERATURE CONTROLLER

36.81

AMBIENT AIR IN. REUSABLE FILTER.
OPTIONAL FRAME:
1) SECURITY FRAME STANDARD ON STAINLESS STEEL
2) SLIDING FRAME STANDARD ON PAINTED
3) OPTIONAL 2" FILTER WITH SLIDING FRAME ONLY

19.00

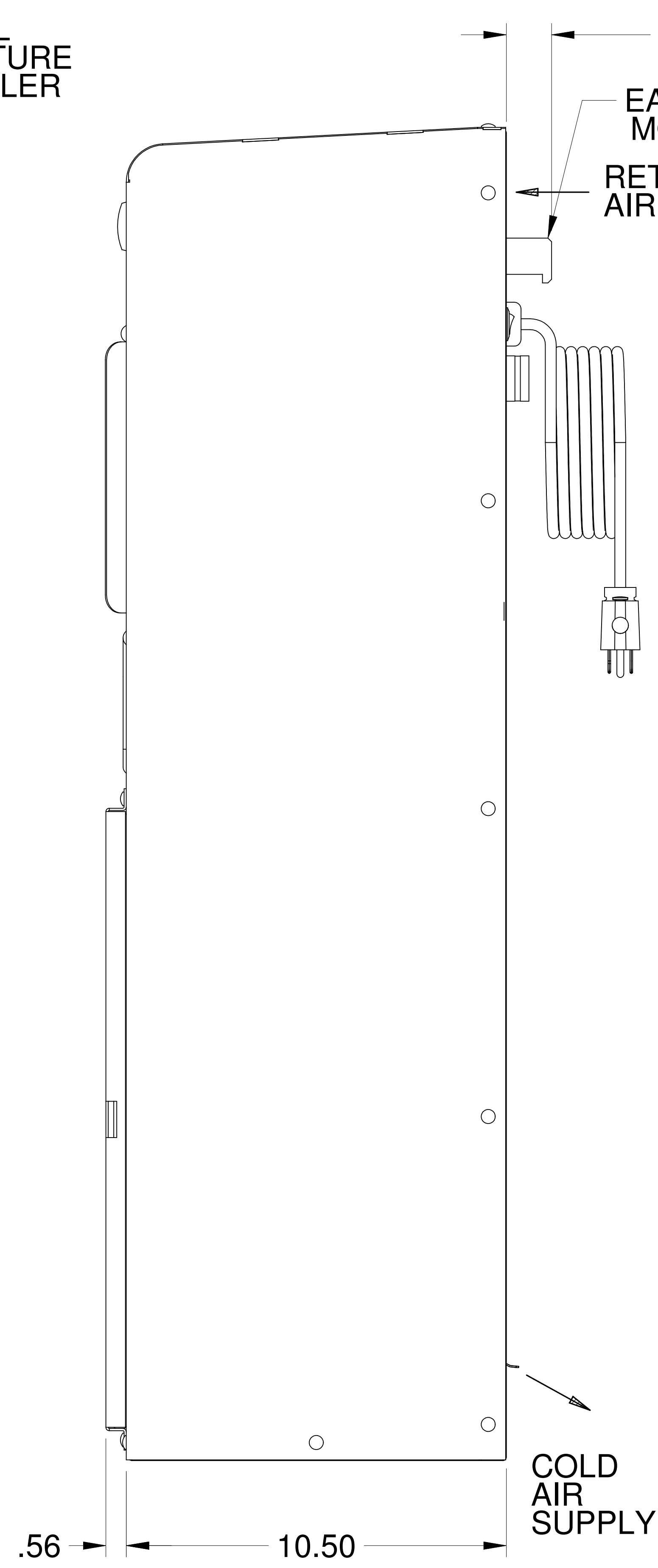

1.25

EASY HANG MOUNTING

RETURN AIR IN

COLD AIR SUPPLY

.56

10.50

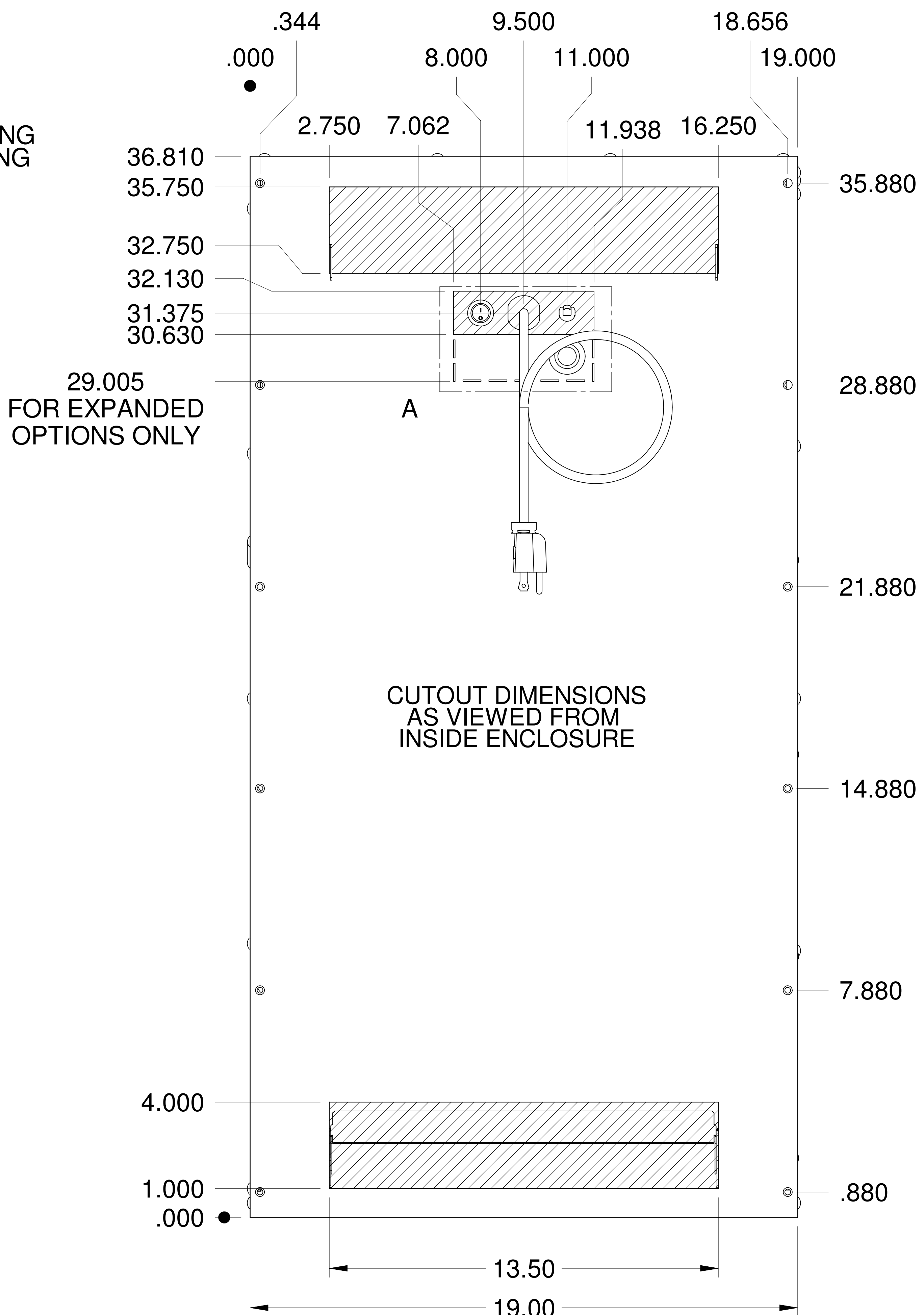

29.005 FOR EXPANDED OPTIONS ONLY

CUTOUT DIMENSIONS AS VIEWED FROM INSIDE ENCLOSURE

TITLE		WIDE FORMAT SERIES	
		WF080	
108 X 72	DWG NO	WF080	REV
SCALE:	WEIGHT:	SHEET 1 OF 1	